



Some Basics for Equipment Servicing

Part 4 — Knowing how to use the oscilloscope effectively as a troubleshooting tool will move you to the front of the equipment servicing class.

By Norman H. Bradshaw,* W8EEF

The two most useful instruments for troubleshooting ham gear are the VTVM (vacuum-tube voltmeter) or FET voltmeter, and the oscilloscope. Of the two, the voltmeter is probably number one, with the scope a close second. Normally, the voltmeter is used to ensure that the operating voltages are correct. If you are unable to detect a malfunctioning component from the voltage tests, the oscilloscope is used to trace a signal from the input to the output of each stage or module, thus locating the problem area.

Oscilloscope Fundamentals

Before using your oscilloscope for equipment servicing, you should be familiar with some fundamentals. A block diagram of a typical oscilloscope is shown in Fig. 1. This scope has two vertical-input channels and is commonly called a dual-trace scope. Each channel operates separately, allowing you to observe two signals at the same time. You can use channel 1 for checking the input signal of the stage under test while displaying the output signal by using channel 2. Either channel may be used as the trigger source to control the horizontal timebase. This trigger signal is used to lock the horizontal system to the vertical signal so that the trace on the screen of the cathode-ray tube (CRT) is stable.

The horizontal timebase is a calibrated sweep system that moves the electron beam across the CRT at a precise rate. This rate is selected by changing the setting of the time-base switch.

The vertical input signal is scaled by the vertical attenuator to limit the input to the

preamplifier. This attenuator is necessary to keep the preamp from being overdriven and to limit the size of the trace on the CRT. A front-panel-controlled diode switch and display control section allows you to select either or both of the input channels. The vertical signal then passes through the delay line. A delay line is a very valuable feature because it allows the horizontal sweep, initiated by the vertical trigger pulse, to start before the vertical signal information arrives at the CRT. This enables you to view the leading edge of the signal. Delay lines vary in delay time from one manufacturer to another and can range from 50 or 60 nanoseconds up to 150 or 200 nanoseconds (1 nanosecond is 10^{-9} seconds). The longer the delay, the more of the signal leading edge

you can observe. After passing through the delay line, the signal is amplified in the vertical deflection amplifier and then applied to the vertical deflection plates of the CRT.

Now on to the horizontal system. A triggered sweep is much more desirable than the older, recurrent system. In the recurrent, or free-running sweep, the horizontal circuit had to be adjusted to run at (or at a submultiple of) the vertical-signal frequency in order to lock the trace on the CRT. The triggered sweep system is controlled by a sample of the vertical signal, using special circuits to start the horizontal sweep in synchronization with the vertical signal. Today, most oscilloscopes use this system.

Accurate timebase calibration is

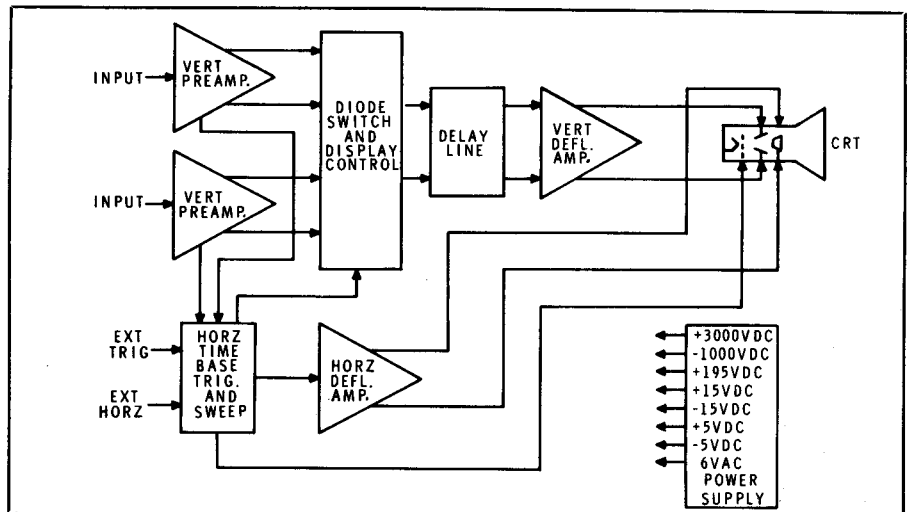

*646 E. Glenlord Rd., Saint Joseph, MI 49085

Fig. 1 — Block diagram of a dual-trace oscilloscope.

necessary if you intend to use the scope for frequency measurements. If you have the timebase switch set for, say, 1 ms/cm, you need to be certain that the sweep is really moving at that rate. Frequency is the reciprocal of time ($f = 1/t$); if your sweep speed is 1 μ s/cm and one cycle of the signal waveform occupies 1 cm on the CRT, the frequency is

$$f = 1/10^{-6} \text{ s} = 1 \times 10^6 \text{ Hz or 1 MHz}$$

Being able to determine the frequency of the signal you are viewing is very useful during troubleshooting.

Selecting an Oscilloscope

There are many considerations involved in the selection of a new or used oscilloscope, including:

- 1) Vertical sensitivity.
- 2) Bandwidth.
- 3) Single- or dual-trace capability.
- 4) Accuracy.

The sensitivity of the vertical amplifier determines the minimum signal amplitude that can be measured. For example, with a 1-mV/cm preamp and a 10 \times probe, only a 10-mV signal is required to produce a 1-cm screen deflection. However, with a 5-mV/cm preamp, a 50-mV signal would be required.

A major consideration is the bandwidth of the oscilloscope. You should buy a scope with as wide a bandwidth as you can afford. Limited bandwidth will reduce your ability to check accurately for harmonics and spurious oscillations. An older scope with a wide bandwidth, in good condition, is a better buy than a new one with a limited response. Regardless of the type of scope you chose, a flat response from dc to the -3 dB bandwidth limit of the scope is important.

You should also consider a scope with dual-trace capability. It is more versatile than a single-trace unit because you can simultaneously view both the input and output signals of a stage to determine gain and phase shift. (See Fig. 2)

Finally, the accuracy of the oscilloscope measurements is important. The vertical attenuators in most scopes have an accuracy specification of 3%. Some are worse, but few are better than that. To meet this specification, most scopes contain some type of calibration signal. This signal is used when adjusting the preamp gain; therefore, the accuracy of your measurements will depend on the accuracy of the calibration signal.

High quality oscilloscopes can be obtained new, used or in kit form. Heath Company has a good selection ranging in bandwidth from 5 to 35 MHz. Most of the displays shown in this article were made using a Heath IO/SO 4510 scope. This is a dual-trace unit with a bandwidth of 15 MHz. It does not have a dual timebase. For comparison, the display shown in Fig. 6 was made using a Tektronix 7704 main

frame with 7A26, 7B80 and 7B85 plug-ins. The Tektronix is a very high quality oscilloscope with a bandwidth of over 100 MHz.

Transceiver Troubleshooting with Your Scope

Before using the oscilloscope, be sure you have isolated the problem as much as possible by using the troubleshooting charts supplied with the service manual (a typical troubleshooting chart is shown below). Are the power supplies operating properly? Does the receiver section work? Or, are the transmitter and receiver sections both dead? If both are inoperative, check the circuits common to both

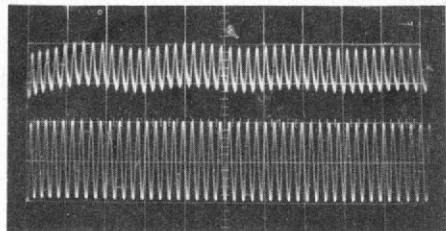

Fig. 2 — A dual-trace oscilloscope allows you to view two signals at the same time. The upper trace shown here is the i-f input signal to a receiver mixer (10 mV/div). The lower trace is the local oscillator input to the same mixer (1 V/div). With all commonly available dual-trace scopes the sweep rate is the same for both traces; in this display the sweep rate is 0.2 μ s/div.

TRANSMITTER		
Problem	Condition	Probable Cause(s)
(1) No power output	(a) IC OK, but no power output	* Defective L ₁ , L ₂ , L ₉ * Shorted VC ₁ , VC ₂ * Defective C ₆₆ * Low bands only: Defective C ₅ - C ₈ * Defective RL ₂
	(b) IC OK, but no output on a particular band	* Cold solder joint between band switch and tank coil * Defective band switch
	(c) No IC indication	* Defective 6146B * ACC plug not correctly wired or improperly seated * No screen voltage at 6146B because of defective L ₁₈₀₄ , band switch
	(d) Idling IC OK, but no drive	* Defective 12BY7A * No screen voltage because of defective R ₁₀₀₃ , C ₁₀₀₉ , R ₁₀₀₇ - R ₁₀₀₉ * Defective Q ₁₀₅ , Q ₁₀₆ or Q ₄₀₅
(2) Poor TX	(a) No power output on LSB only	* Defective X ₅₀₂
	(b) No power output on USB only	* Defective X ₅₀₃
	(c) No power output on both USB/LSB	* Defective RL ₅₀₁ , Q ₅₀₂ , D ₂₄₀₂ * No vox operation: defective or grounded MIC or PATCH jack * Defective Q ₅₀₃ , Q ₅₀₄ or Q ₅₁₂
	(d) No power output on CW/TUNE	* Defective X ₅₀₄ , Q ₄₀₁ , D ₂₄₀₂
	(e) No CW keying	* Defective mode switch, Q ₁₀₀₁ , and associated circuit * Defective D ₅₀₆ if carrier hangs up
	(f) No modulation on AM	* Defective Q ₂₄₀₁ - Q ₂₄₀₇ , D ₂₄₀₁ , X ₂₄₀₁
(3) Abnormal meter	(a) Cannot set ALC meter	* Defective C ₁₀₁₆ * Defective Q ₄₀₅ , VR ₄₀₁ * Defective meter switch or RL ₁

This section of the FT-101ZD troubleshooting chart is typical of that found in the better service manuals available for amateur transceivers.

transmit and receive. The i-f system is common to both, so activate the internal crystal calibrator (or use a crystal oscillator if the transceiver is not equipped with a calibrator) and tune the receiver to a point near one of the 100-kHz or 25-kHz divisions on the dial. Usually the calibrator is inserted at, or near, the antenna input. The calibrator is designed to have an output signal rich in harmonics, so do not expect to see a pure sine wave on your oscilloscope. Fig. 3 shows the scope display of the calibrator signal in a typical amateur transceiver. Using the scope, trace the signal through the receiver rf amplifier to the mixer circuit. Then check to see if the VFO (variable-frequency oscillator) is working and a good signal is being injected into the mixer (the VFO is also common to both receive and transmit). The VFO waveform normally appears as a sine wave, as shown in Fig. 4. The output of the mixer will be at the i-f of the receiver (Fig. 5).

To prevent loading or detuning, a 10:1 scope probe is almost a *must* when signal tracing in rf and i-f circuits. This probe must be adjusted to the vertical input channel it is to be used with. A fast rise, 1 kHz square-wave signal is normally used when making this adjustment. With the square-wave signal applied, the probe is adjusted to display the best waveform (sharp corners, with no over- or under-shoot). This is shown in Fig. 6. If a calibrator signal is not provided on the oscilloscope, the square-wave output of a function generator can be used for this adjustment.

After you have found the circuit where the signal goes in, but nothing comes out, use your high-impedance (10 megohm or greater) voltmeter to check the voltages on the transistor leads. There are times when voltage measurements will not prove a transistor is bad, so you may have to turn the rig off and use an in-circuit transistor tester. Under certain conditions, an in-circuit transistor tester will give an erroneous reading, perhaps showing a short when the transistor is, in fact, good. This may occur when there is a diode, a very low value resistor, or another direct-coupled transistor in the circuit. Unfortunately, the only way to be sure is to unsolder the base lead from the circuit board and recheck the transistor. The base lead is the only one that has to be disconnected, as it is the control element of the transistor. Also be sure that the polarity switch on the tester is in the correct position. Checking a pnp transistor with the tester in the npn position will show an open every time, as the transistor junctions will be reverse biased.

With equipment containing tubes, the first step after locating the defective stage is to change the tube. If this does not cure the problem, check the voltages at the tube socket. Be sure to check the voltage on the screen grid, if the tube has one.

Without screen voltage, the tube will not conduct.

If the VFO and mixer circuits are operating properly, continue tracing the signal back through the unit to the i-f stages. Check crystal oscillators, mixers, buffer amplifiers and filters (ssb and cw) to be sure they are working. Remember, the malfunction almost has to be in the i-f section if both the transmitter and receiver are inoperative (assuming that the power supplies are working).

You may wish to try a troubleshooting technique that I have used for many years. When I find a circuit that is operating

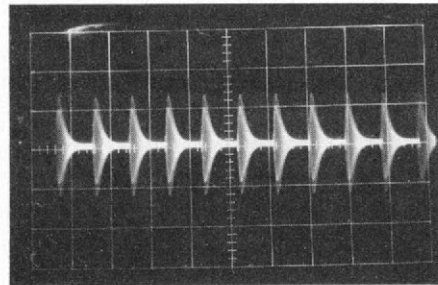

Fig. 3 — Oscilloscope display of the calibrator signal in an amateur transceiver. The calibrator signal is a useful signal source during signal tracing. Each horizontal division represents 20 μ s (20 μ s/div) and the vertical divisions are 100 mV (100 mV/div).

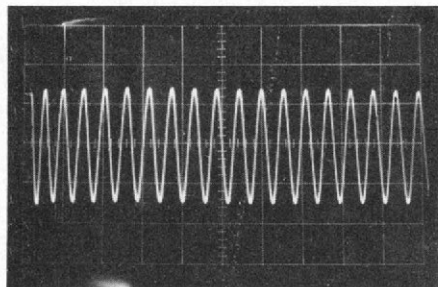

Fig. 4 — The VFO signal should appear as a sine wave. Shown here is the VFO input signal at the first mixer of an FT-101ZD. Oscilloscope sensitivity is 50 mV/div and the sweep rate is 0.1 μ s/div.

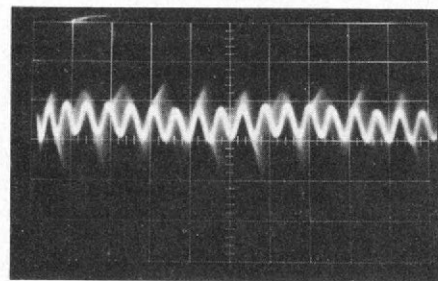

Fig. 5 — Using the calibrator as a signal source, the output of the receiver mixer appears as shown here. (10 mV/div and 0.1 μ s/div). Traces of the calibrator signal can be seen "riding" on the mixer output signal. While normal for this rig, this may not occur in other equipment.

properly, I move back through the circuit four or more stages. If that stage is not operating, I move ahead two stages and test again. You can cut the number of tests needed in half by using this procedure.

Suppose the transmitter is working and loads up properly into your dummy load, but no sound is heard from the speaker during receive. The first item you should check is the speaker. Disconnect it from the rig and use an ohmmeter to test for continuity. If it is okay, and your S meter indicates a signal, the problem is most likely to be in the audio amplifier. Fig. 7 shows the oscilloscope display of the audio signal at the demodulator output. As there are only two or three stages in the audio section, the problem should be easy to locate. A reading on the S meter is a good indication that the circuits from the antenna through the i-f stages are operating.

Because the carrier signal is present, transmitter problems are often easiest to locate when the rig is in the cw (or tune) mode. This also eliminates the problem of having to connect an audio signal generator to the microphone input. Of course, if the rig works on cw but not on phone, the problem must be in either the VOX (voice-operated switching) or microphone amplifier, which means your search

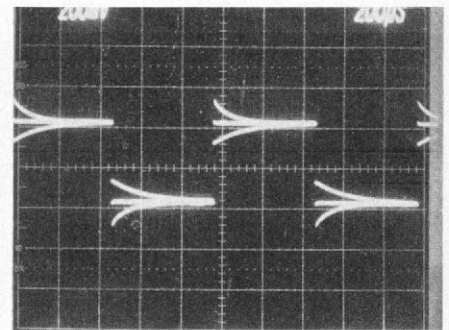

Fig. 6 — High-impedance, or 10:1, probes must be adjusted for the vertical input channel they are used with. The display shown here is a triple exposure. The upper and lower traces show over and under compensation, respectively. The center trace is the correct waveform. This display was made using the Tektronix 7704 oscilloscope.

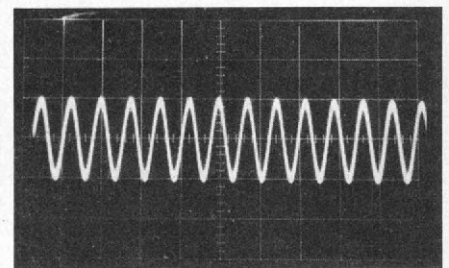

Fig. 7 — The audio output of the receiver demodulator should appear as shown here (50 mV/div and 20 ms/div).

has been narrowed to a couple of stages. Remember, the microphone could be bad! If you have a hybrid transceiver, one with vacuum tube driver and "finals," make sure that the filaments are lit. Also make sure that all voltages in these areas are correct.

Be careful — working near high voltages is dangerous! Look at the rf choke in the final amplifier plate circuit to see if it is damaged. A shorted final or loss of grid bias can overload the choke, causing an open circuit. If you are unable to detect any damage visually, shut the rig down, wait a few minutes for the power supplies to bleed off, and then check the choke with an ohmmeter. If the choke is okay, turn the rig on and check the final-stage screen voltage. Without screen voltage you will have little or no output.

Because of the high dc voltage, direct connection to the driver plate circuit could damage the probe or the oscilloscope. Placing a 10X probe near the driver tube plate tank circuit (or near the glass tube envelope) will give a good indication of rf on the scope if the stage is functioning properly. The display shown in Fig. 8 was obtained in this manner. Transistor drivers and final stages are current-operated devices, so you can usually

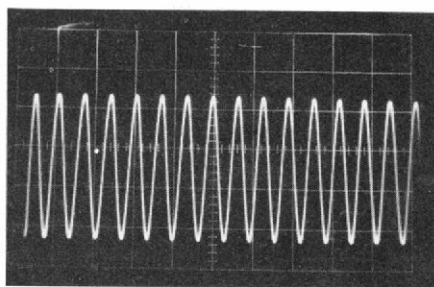

Fig. 8 — This display was obtained by placing a 10:1 probe near the glass envelope of a 12BY7A driver tube while the transmitter was being operated into a dummy load. The power output was adjusted to 50 W. A fairly high scope sensitivity (0.2 mV/div) was used with a sweep rate of 0.2 μ s/div.

probe these stages without fear of damage to the scope or probe.

Suggestions

You will need the service manual for your rig if you are serious about doing your own repair work. Most manuals contain block diagrams showing the transmit and receive signal paths through the unit. These allow you to see the overall signal flow and are very helpful during signal

tracing (see Fig. 9). The manual will also include a detailed description of each circuit, and most will provide a troubleshooting chart to help you isolate a problem in minimum time. There will be times when your particular symptom does not appear to be covered in the chart; this is when your scope and voltmeter become most valuable in tracking down the problem.

If you do not already have them, extender boards and/or cables are a good investment. With them you can get the suspected circuit out where you can work on it. It is almost impossible to troubleshoot modern transceivers with all the circuit boards in place. When inserting or removing boards, be sure the power to the rig has been turned off. You may end up with more trouble than you started with if you don't!

A very serious suggestion — if you want to realign your transceiver, be sure your equipment is adequate for the job. The signal generator used should be of "lab quality" frequency accuracy. It should also be "rf tight." That is, there should be no signal leakage from the box except for the signal coming from the output connector. The generator should also have an accurately calibrated attenuator. Several

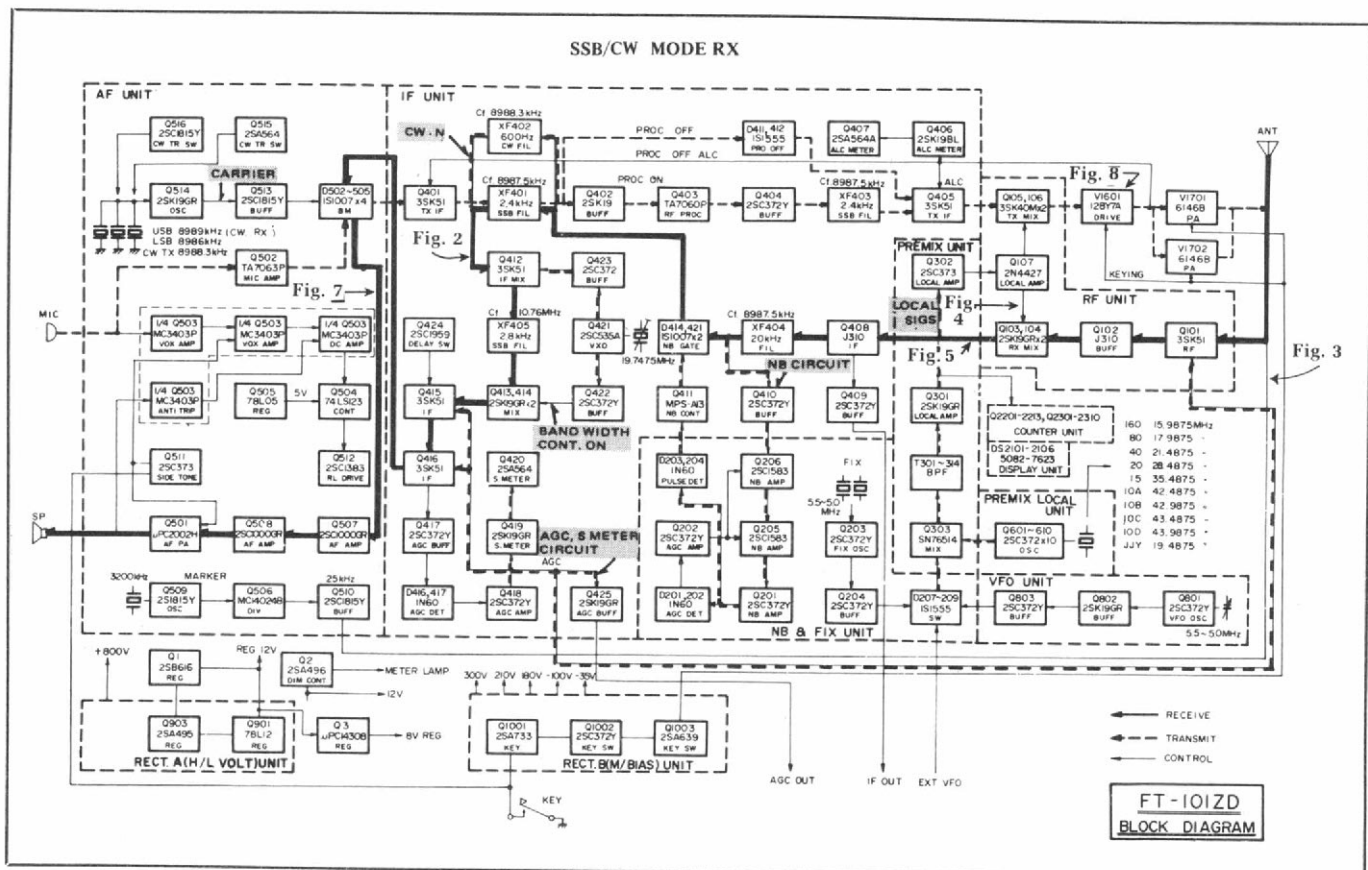

Fig. 9 — The block diagram of the FT-101ZD transceiver. It is representative of those found in most service manuals. The figure numbers shown on the diagram indicate the points at which some of the oscilloscope displays were made.

Glossary of Terms

Bandwidth — The range of signal frequencies that can be displayed with a specified accuracy. Typically, the frequency at which the scope response is 3 dB less than the response to a low-frequency signal of the same amplitude is considered to be the upper bandwidth limit. Most scopes respond to dc signals; thus, the lower bandwidth limit is dc (or 0 Hz).

Delay Line — An electrical circuit through which the passage of a signal is delayed by a fixed length of time.

Diode Switch — A circuit in which diodes are used to select a particular signal path. These electronic switches are controlled by dc voltage levels and are capable of rapid switching.

Dual-trace — The capability of simultaneously displaying two signals. Normally, two identical vertical amplifiers are provided. Electronic switching is used to select the vertical amplifier output to be displayed.

Horizontal sweep/timebase — Movement of the electron beam (and visible spot) across the cathode-ray-tube face in a uniform, horizontal motion. The horizontal timebase is the circuitry used to produce this motion.

Horizontal sweep-rate — The rate, in seconds per cm or division, at which the

horizontal sweep occurs.

Probe, 10 × or 10:1 — An oscilloscope probe that attenuates the signal applied to the vertical input by a factor of 10. In addition to reducing the signal amplitude, a 10 × probe also provides a higher input impedance (typically 10 MΩ).

Probe compensation — 10 × scope probes contain an adjustable frequency-compensating circuit to ensure a constant attenuation factor over the frequency range of the probe.

Rise time — The length of time required for a signal to increase in amplitude from a low level (10% of the maximum amplitude) to a high level (90% of maximum).

Triggered sweep — A triggered sweep system uses a trigger signal to begin the horizontal sweep, thus synchronizing the sweep and the trigger signal. The trigger signal is normally derived from the vertical input signal.

X-Y display — The display of two signals, one producing vertical deflection in the normal manner, while the second signal is applied to the horizontal-deflection input. No horizontal sweep is required for this type of display. An X-Y display allows two signals to be compared in terms of amplitude, frequency and phase.

other pieces of equipment, such as an rf voltmeter, scope, dummy load and an accurate power meter, are almost necessities if you are to do a good job. Trying to do the alignment with mediocre equipment can result in a rig so badly misadjusted

that it has to be returned to the service center for calibration. So beware before you start turning adjustment screws! This also applies during troubleshooting; don't change adjustments if the rig is not working. 99.9% of the time the problem

Strays

MIXED-BAND DXCC WITH 2 WATTS

□ Achievement, in whatever form, suits amateurs. That's the real "bottom line" for our interesting pastime. For some, this comes when designing equipment, earning a top score in contests or having the loudest signal in town. For others, this form of achievement is seen in QRP operation in quest of WAS, WAC or even DXCC. Although some operators of high power have been heard sending CQ CQ CQ, NO QRP STNS PSE, a stigma should not be attached to the low-power operator: He or she must work even harder to reach a specified operating goal than those with 100- or 1000-watt transmitters.

Hans Meurer, W2TO of Ridgewood, New Jersey, is but one QRP enthusiast who garnered 100 countries for a DXCC award. His rig was a Heath HW-8 transceiver (approximately 2 watts of output), which uses a direct-conversion receiver. Ordinary dipole antennas were used to confirm the first 76 countries (antenna height was 45 feet). A TA-33 tri-

band Yagi served as the antenna for the remainder of his needed countries. He had 60% of his contacts on 15 meters, 35% on 20 meters and 5% on 40 meters, along with a J3 QSO on 80 meters. Hans made some of his contacts by squeezing into big DX pileups! That's where patience and skill of operating become significant for QRPers.

It took roughly 1-1/2 years of somewhat casual operating to collect the 100 cards for DXCC. After 47 years as a licensed amateur, Hans offers this advice: "For a truly exciting challenge, the kW boys, keyboard wizards, Honor Roll elite, OSCAR ops and 2-meter buffs should switch to QRP DXing." He may have a good point! — Doug DeMaw, W1FB

AMSAT SOFTWARE EXCHANGE

□ Need a Phase III orbital prediction program? The first program offered by the AMSAT Software Exchange was written by AMSAT President Dr. Tom Clark, W3IWI. It is available for the TRS-80 disk and cassette, Apple/II diskette, Microsoft BASIC and Digital Research PL/I-80. For a complete description and ordering information, send an s.a.s.e. to AMSAT Software Exchange, Box 338, Ashmore, IL 61912. Proceeds will be donated to AMSAT in support of the Phase III satellite.

is a bad component and not incorrect adjustment.

Final Notes

A systematic approach to troubleshooting will minimize the time necessary to repair your equipment:

- 1) Observe the symptoms.
- 2) Remove the covers and use your eyes and nose to locate the problem area before turning the rig on.
- 3) Check the symptoms and probable causes in the troubleshooting charts contained in your service manual.
- 4) Measure the power supply voltages to be sure they are all within tolerance.
- 5) Follow the signal-tracing procedures outlined in this article.
- 6) Safety first — exercise caution whenever you must troubleshoot circuits with the power applied.

Here is to successful troubleshooting. May your rig last forever and you never need to repair it! But, if you do, I hope this article will get you started in the right direction.

Acknowledgments

I wish to express my sincere thanks to Heath Company and to Yaesu Electronics Corp. for their permission to use material from their service manuals. 

INDUCTOR STACK SHORTAGE

□ Ed Wetherhold, W3NQN (ARRL TA), is temporarily out of 88-mH inductor stacks of the type used in the construction of the audio filter described in December 1980 QST. He asks that those who have already requested stacks be patient. Amateurs wishing to obtain them are requested to send a large s.a.s.e. for details and design information for cw, RTTY and speech filters to Ed Wetherhold, W3NQN, 102 Archwood Ave., Annapolis, MD 21401.

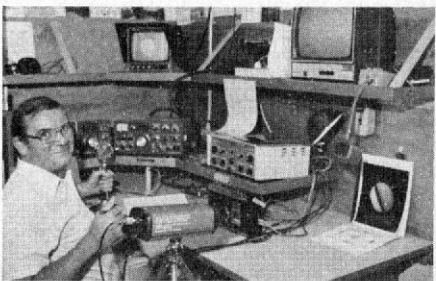

Dick Pletý, K6SVP, takes a break from his slow-scan TV position at the W6VIO commemorative operation during the Voyager I Flyby of Saturn last October. Over 8600 contacts were made during the event; the Jet Propulsion ARC, Pasadena, California credits this success to thorough planning and, of course, Voyager I's spectacular flight. (K6PGX photo)